

since 1964

HASENKOPF
INDUSTRIE
MANUFAKTUR

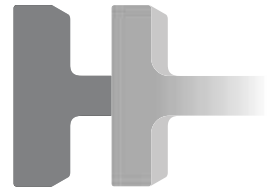

PARAPAN
PRODUCTS



CUSTOM PRODUCTION

Hasenkopf is Craftsmanship. For half a century the company has been manufacturing distinctive and unique products and fulfilling our customers' individual requests, however unusual. Hasenkopf sees itself as a manufacturer because – now more than ever – the word stands for excellent craftsmanship, reliable quality and tailor-made perfection.

SERIES PRODUCTION

Hasenkopf is Industry. With a workforce of around 160, a 15,000 m² production area and the very latest technological facilities even our series products can offer tailor-made perfection. That is why we have Industrial Manufacture in our name, because Hasenkopf's customers can enjoy all the advantages of industrial production, such as fast order processing, efficiency and just-in-time delivery.

BRILLIANT PRODUCTS MADE OF PARAPAN®

Its smooth high-gloss surface and manifold processing options make Parapan not only eminently suitable for conventional furniture fronts and covers but also for unusual shapes and designs. This homogeneous acrylic material is evenly colored right through, does not fade and is available in 20 different colors. Our standard colors are always in stock. Milling, thermal forming and polishing are used to give Parapan surfaces and objects the desired-form – and to bring brilliant long-lasting color in bathrooms, kitchens and other areas. At Hasenkopf we have consolidated all our materials and processing expertise under one roof, greatly simplifying project handling for our customers and partners.

CONTENTS

Fronts, bodies, and covers	Surfaces and sections	P. 08
	Handles	P. 09
	Edge styles	P. 10
	Processing options	P. 12
	Adhesive joints	P. 13

Complete solutions	P. 14
--------------------	-------



ELEGANCE FOR YOUR ROOMS:
HIGH-GLOSS PARAPAN SURFACES
FOR EFFECTIVE HIGHLIGHTS.



A

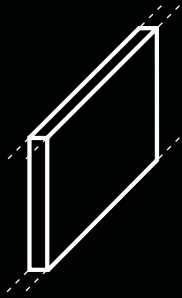

Surfaces and sections [→ P. 08]

B



Handles [→ P. 09]

C



Edge styles [→ P. 10]

D

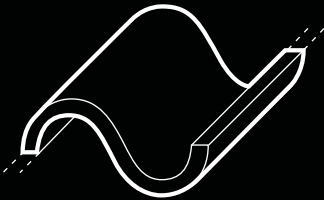

Processing options [→ P. 12]

E

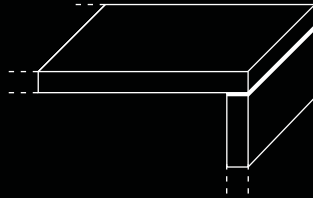

Adhesive joints [→ P. 13]

PARAPAN PROVIDES FOR HIGH-GLOSS ELEGANCE RIGHT ACROSS THE BOARD. WE POSSESS THE TECHNOLOGY AND SKILLS TO PROCESS THIS ACRYLIC MATERIAL IN SUCH A WAY AS TO PRECISELY FULFILL OUR CUSTOMERS' DEMANDS AND DELIVER THE GOODS ON AN ORDER-SPECIFIC BASIS FOR STRAIGHTFORWARD HANDLING.



FRONTS, BODIES AND COVERS



SURFACES AND SECTIONS

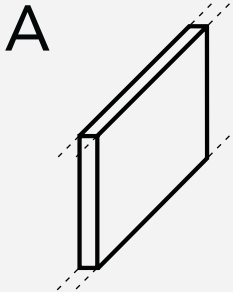

SURFACES

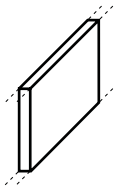

SECTIONS

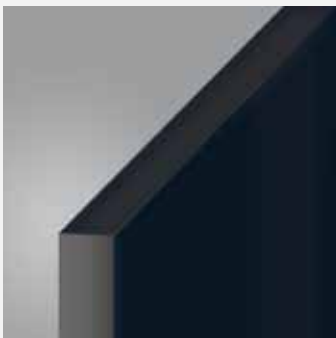
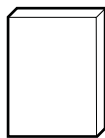

4 mm or 18 mm

- › Parapan surface: 4 mm or 18 mm
- › covered on both sides with a protective adhesive film
- › seamless design, available for areas up to 2980 x 1980 mm
- › surfaces with milled or polished edges
- › other types of edge processing available
- › surfaces delivered fully finished

4 mm or 18 mm

- › Parapan sections: 4 mm or 18 mm
- › covered on both sides with a protective adhesive film
- › seamless design, available for areas up to 2980 x 1980 mm
- › edges not treated (saw-cut)
- › for subsequent processing by the customer

Please contact us for the technical details of further processing.

HANDLES

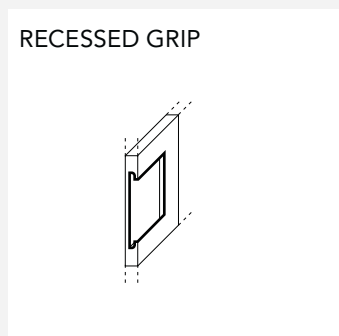
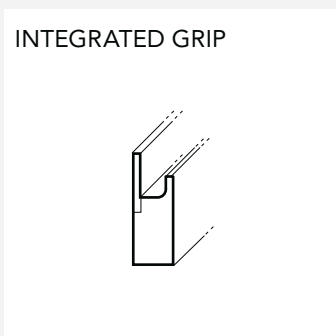
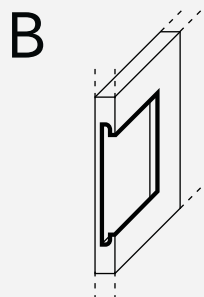

Article no.
PAR GRIFF-S

› including 4 mm Parapan crosspiece
› crosspiece up to 50 mm high

Article no.
PAR GRIFF-M / PAR GRIFF-L

› oval-shaped recessed grip with
angled edge and 4 mm Parapan at
rear
› oval-shaped milled cutout
hand-grip

EDGE STYLES

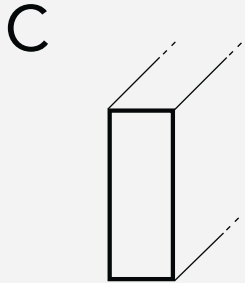

CHAMFERED EDGE

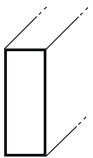

STANDARD R2

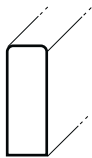

ROUNDED R5-10



ANGLED EDGE 45°

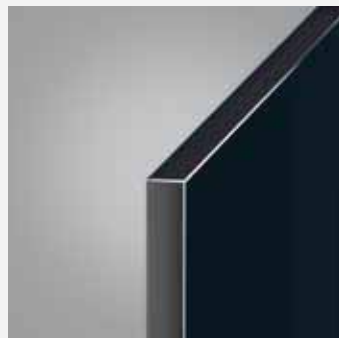
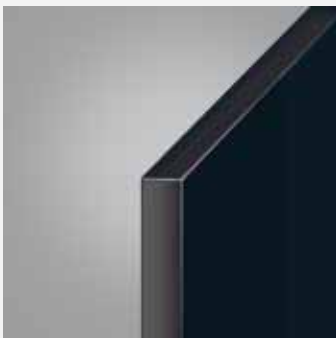
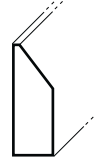

Article no.
PAR KRD

Edge processing
› for 4 mm and 18 mm board
› slightly chamfered and polished

Article no.
PAR KRD2

Edge processing
› standardly with R2 for 18 mm board

Article no.
PAR KRD5

Edge processing
› rounding 5-10 mm for 18 mm board

Article no.
PAR FASE

Edge processing
› angled edge: 45° for 18 mm board
› designs with different angles
available on request

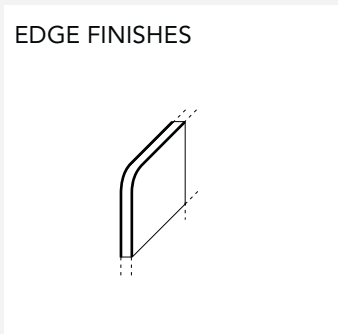
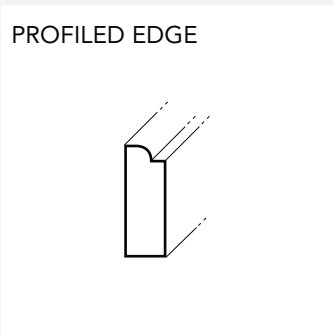

Article no.
PAR PROF

Edge processing
› profiled edge
› designs on request

Edge processing
› radius with no edge processing
for 4 mm / 18 mm boards

› beveled
› notched
› rounded

PROCESSING OPTIONS

D

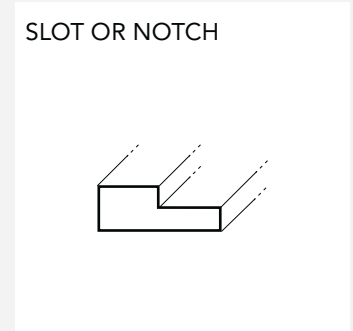
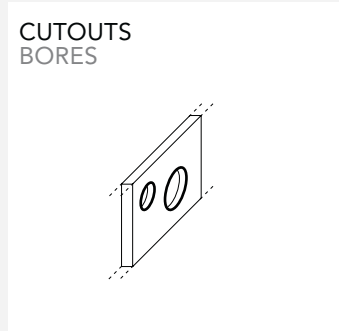
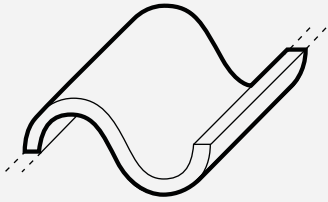

Article no.
PAR 2D / PAR 3D

› thermal forming
› designs and technical details on request

Pre-bored for fittings

- › recessed for hinges
- › if required, delivered with hinges
- › pre-bored for handles
- › pre-bored for locks
- › round, oval or rectangular cutouts
- › cutouts WITH or WITHOUT edge processing

Article no.
PAR LOCH

› pre-bored for placement of shelves

Article no.
PAR SARI

› slot or notch milling
› NOT polished

ADHESIVE JOINTS

E

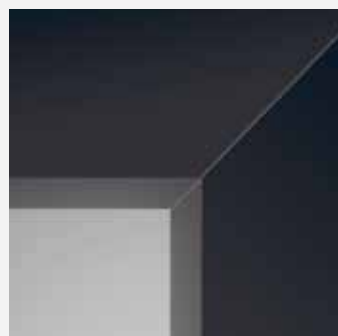
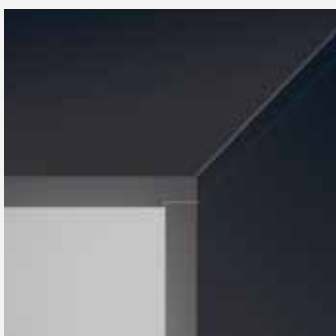
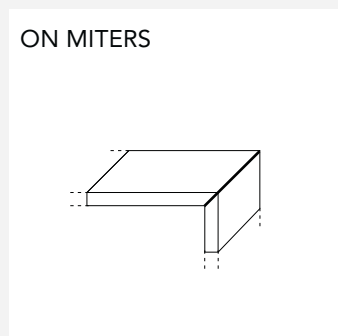
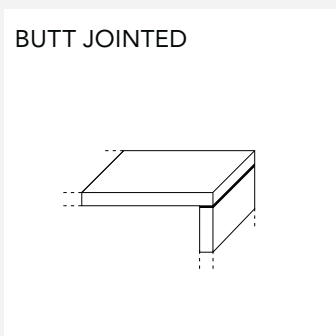
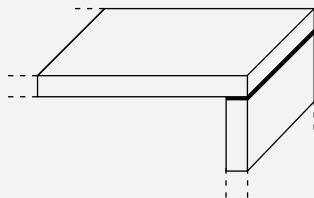

Article no.
PAR APVP / PAR APVS

› butt joining Parapan sections
› Caution: Adhesive joints may be visible!

Article no.
PAR APVG

› joining Parapan sections on miters from 1000 mm / meter length
› Caution: Adhesive joints may be visible!

COMPLETE SOLUTIONS BODIES AND COVERINGS



ENCOURAGE SALES

Parapan is a brilliant alternative to conventional materials for the manufacture of sophisticated shop-fittings.

Parapan counter and wall facings from Cole Joinery on behalf of CD UK for Dior [Photo: Evonik]



DURABLE EDGES

This homogeneous through-dyed material means that there is no difficulty in implementing individual edge designs such as furniture fronts without handles.

Parapan counter and wall facings from Cole Joinery on behalf of CD UK for Dior [Photo: Evonik]



ATTRACTIVE

Shopfitters can use Parapan to create a wide variety of attractive product presentation elements.

Occhio Flagship Store in Munich for the joinery Abend-schein, Munich for Axel Meise Licht, Design Mose Design, Munich [Photo: Axel Meise Licht]



ADAPTABLE

Parapan can also be applied to existing furniture and adapted for special requirements such as ventilation slits.

Swiss Bundeshaus (Switzerland) purchased by Schneider Innenausbau, Switzerland [Photo: Schneider Innenausbau]



COLORFUL

Parapan guarantees evenly glossy furniture fronts in 20 colors.

[Photo: Evonik]



INVITING

For exhibition stands Parapan can also provide inviting and eye-catching accents.

Hasenkopf exhibition stand for Holz-Handwerk 2010 [Photo: Hasenkopf]

MANIFOLD POSSIBILITIES. ONE STRONG PARTNER.

HASENKOPF'S PRODUCTS ARE AT HOME ALMOST ANYWHERE.

With our advanced processing techniques and versatile expertise in a wide variety of premium materials we offer our customers and partners tailor-made solutions for almost all areas of life and work, coupled with project support from the planning stage through to the implementation.

CORIAN

With our two-dimensional and three-dimensional processing methods we can coax these high-quality minerals into almost any desired form, to create basins, worktops, counters, wall paneling, etc.

WOOD

Since 1964 we have been using wood and wood-based materials to manufacture high-quality ready-to-assembly drawer systems. We also cooperate with partner processing specialists to realize even large-scale products.

ACRYL

Its transparency, colors and design possibilities added to its outstanding processing properties make Acryl an extremely versatile material, for instance, for sophisticated indoor fittings and design.

FRESCATA

Frescata is the name we have given to our program of creatively designed surfaces and coverings in a variety of materials and combinations individually customized with multiple textures and finishes.

AND MORE

In addition to wood, Corian, Parapan and acryl we also offer products and services based on other premium materials, such as gypsum fiberboard. So we have suitable materials for any requirement.

LIFE & LIVING



Table design manufactured in Corian® for Veech Media Architecture (VMA) [Photo: Heiner Heine]

We cooperate with well-know designers to create not only distinctive and impressive one-off objects but also full sets of furnishings and fittings to visibly enhance your quality of life and living.

BATHING & WASHING



"Corian® Designbadewanne Po", Boffi S.p.A., (2003 Lentate sul Seveso, Milan), Design Claudio Silvestrin [Photo: Boffi S.p.A.]

We open up new design possibilities for bathrooms and showers. Our mineral materials guarantee the most hygienic conditions.

COOKING & EATING



Corian® kitchen worktop for ALNO [Photo: ALNO]

For kitchens – the core environment of our lives – we create both functional and beautiful solutions.

STORING & ORDERING



MDF drawers with curved fronts for Frauenbrunnen, Switzerland [Photo: Frauenbrunnen]

With individually designed furnishings and our proven high-quality drawer solutions we provide for elegant order and practical living.

WORKING & REPRESENTING



Ceiling lights and furniture made of Corian® and wood on behalf of Stonner IP for Münchener Rück [Photo: Stonner IP]

For offices and other working environments we offer suitable and practical furnishings and designs.

HEALING & CARING



Medical worktops made of Corian® for Karl Baisch [Photo: Karl Baisch GmbH]

For healthcare institutions we create environments that promise comfort and hygiene as well as being pleasant to use and easy to clean.

HOSTING & RECEPTIONS



Counter installation made of Corian® and wood on behalf of Riedl / Team Concept for BMW Welt Munich

We facilitate attractive and functional furnishing solutions for caterers and hoteliers, who are happy to see our products among their permanent residents.

PRESENTATION & SELLING



Parapan® counter and paneling on behalf of Cole joinery and CD UK for Dior [Photo: Evonik Degussa]

With our attractive furnishings and versatile designs we can help to create retail premises and fair exhibits to achieve the very best in means of presenting a company's products and services.

LIGHTING & HIGHLIGHTING



"Corian® Nouvel lumieres" (2007 Milan week of design), design Jean Nouvel, Foto Leo Torri image courtesy of DuPont™ Corian® (all rights reserved on design and photo)

Some of our materials are translucent and therefore eminently suitable for impressive lighting installations. Elegant surface finishes also offer numerous attractive possibilities.

OUR OFFER FOR YOUR SUCCESS.



CREATE MORE VALUE TOGETHER

Our customers in trade and industry, design and architecture value us as a reliable and competent partner for any type of challenge. With our experience and knowledge of the very latest cutting, forming and molding techniques to supplement your own areas of competence, you can satisfy the requirements of sophisticated tendering projects and win orders for your company. As part of a value-add chain that benefits all its participants we can reinforce your capacity and help you to implement your projects successfully. See for yourself how effective it can be.



INQUIRY
TO YOU

OFFER
WITH US

ORDER
FOR YOU

EXECUTION
WITH US

SUCCESS
FOR YOU

1

2

3

4

5

You have an inquiry or an invitation to tender on a project for which you could use some assistance.

We can help you with costing your proposal, clarifying technical details and more, for instance by providing appropriate samples.

With Hasenkopf as an efficient external supplier your competitive proposals will win the order.

We can help you at the planning stage and guarantee timely production and delivery, directly to the site, if desired.

It is your achievement that will be in the foreground – your customers will never know we exist. The success is entirely yours.

since 1964

HASENKOPF
INDUSTRIE
MANUFAKTUR

MARTIN ET KARCZINSKI

WE TAKE INDIVIDUAL IDEAS AND
GIVE THEM THE PERFECT SHAPE
FOR LARGE SCALE PRODUCTION.
WE WILL GLADLY ADVISE YOU,
RIGHT FROM THE PLANNING AND
DEVELOPMENT STAGE. JUST GIVE
US A CALL! WE ARE ALWAYS READY
TO LISTEN YOUR IDEAS.

T +49 . (0) 86 77 . 98 47 50
PARAPAN@HASENKOPF.DE